

Part No:	GH-200-W
Holding Capacity:	400Kg
Bar Opens:	84°
Handle Opens:	90°
Weight:	0.569Kg
Spindle Supplied:	FC-38312
Flanged Washers:	FW-380

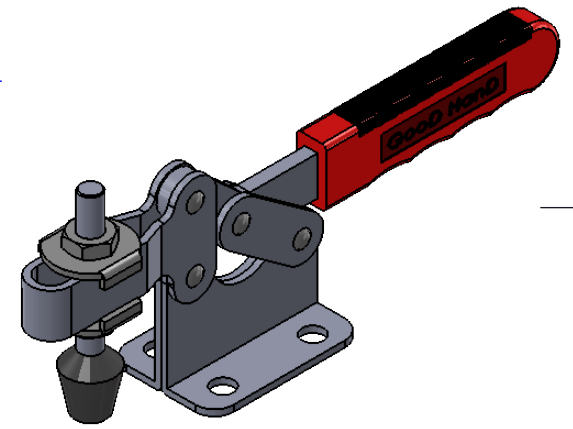
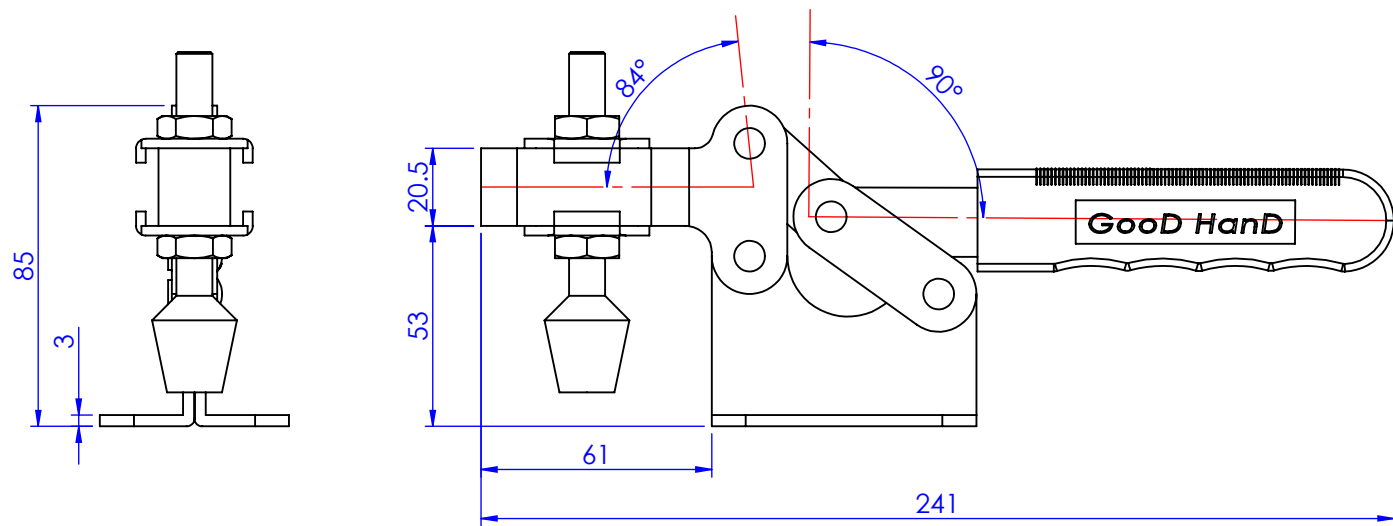
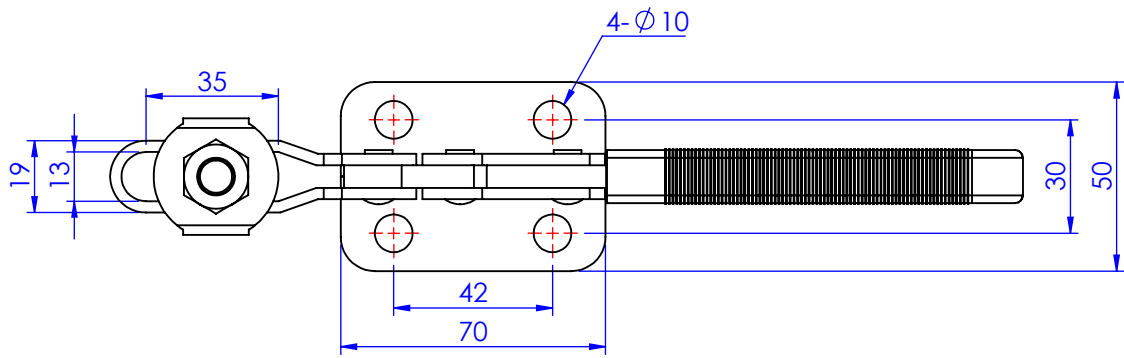

Unit:mm  
Scale : 1:2

 **Good Hand Enterprise Co., Ltd**

TITLE:		
DWG NO.	GH-200-W	A4